

Hybrid fiber production: a wood and plastic combination in transgenic rice and Tamarix made by accumulating poly-3-hydroxybutyrate

Noboru Endo^a, Kouki Yoshida, Miho Akiyoshi*, Sumihide Manji

Taisei Corporation Technology Center, 344-1, Nase-cho, Totsuka-ku, Yokohama 245-0051, Japan

* E-mail: miho.akiyoshi@sakura.taisei.co.jp Tel: +81-45-814-7226 Fax: +81-45-814-7257

Received October 7, 2005; accepted January 31, 2006 (Edited by K. Yoshida)

Abstract Two genes for acetoacetyl-CoA reductase (*phbB*) and poly-3-hydroxybutyrate (PHB) synthase (*phbC*), from *Ralstonia eutropha* were transformed into rice and Tamarix to change their fiber characteristics by producing PHB in these plants. Expression of the genes was detected by RT-PCR. The enzyme activity of *phbB* was confirmed by measuring NADPH-dependent acetyl-CoA consumption. Western blot analysis was used to detect the protein product of *phbC*. PHB accumulated in the transformed rice to an average level of 3 mg g⁻¹ dry weight. Similar levels were detected in the transformed Tamarix. Wood and plastic combination (WPC) boards were prepared from the transformed rice and Tamarix. Differential scanning calorimetry (DSC) analysis of rice WPC board measured a melting point (T_m) that was distinct from those of boards made of 100% PHB or PHB-blended cellulose. A unique DSC peak was present for the sample of transformed rice. A measure of pressure deformation showed a higher compression resistance in the sample made of transformed rice and the PHB-blended sample. Analysis of thermal extension showed enhanced stabilities for the PHB-blended sample and the samples made of transformed rice and Tamarix. It was also shown that transgenic blending of PHB prevented moisture absorption in samples made from rice and Tamarix. These results indicated that the accumulation of the plastic in the plants results in improved characteristics in the sample boards.

Key words: Genetic engineering, poly-3-hydroxybutyrate, rice, Tamarix, wood and plastic combination.

A wood and plastic combination or composite (WPC) is a wood material that is filled with plastic monomers, which are then polymerized by radiation, heat, or pressure (Karpov et al. 1960). WPC products have been used to make hydrophobic wood, construction board, and paper materials. The production of WPC materials, however, is costly due to the petroleum chemistry, which requires sophisticated technology and is not environmentally friendly. Due to the production costs, the environmental implications, and recent warnings about potential environmental hazards, such as the associated volatile substances being causal materials for sick house syndrome, alternative biomaterials are desired.

Poly-hydroxyalkanoates (PHAs) are biodegradable plastics that can be good alternatives for the production of WPC materials, provided that well-established technologies are available. Poly-3-hydroxybutyrate (PHB) is a PHA that is widely used in industrial production. Three genes are known to be involved in the synthesis of PHB: 3-ketothiolase (*phbA*), acetoacetyl-

CoA reductase (*phbB*), and PHB synthase (*phbC*). These genes are found in many species of bacteria (see review by Madison and Huisman 1999), and the transfer of genes from bacteria to plant cells has been demonstrated (Poirier et al. 1992). Although there are many reports about PHB production in transgenic plants, the levels of PHB accumulation have fallen short of expectations: 14% DW is the highest level reported in *Arabidopsis* (Nawrath et al. 1994), <10 μg gFW⁻¹ in tobacco (Nakashita et al. 1999), 1–1.7% DW in *Brassica napus* (Houmiel et al. 1999), and 4–5 μg gFW⁻¹ in flax (Wróbel et al. 2004). In addition, plant growth has reportedly been inhibited because of depletion of the available pool of acetyl-CoA (Lössl et al. 2003).

In contrast, a report using cotton fibers suggested a simple concept for the biological production of WPC materials. Chowdhury and John (1998) showed that small amounts of PHB accumulated in transgenic cotton fibers, and the PHB changed the thermal properties of the cotton cells. Although the accumulation of PHB in plant cells is not exactly the same as a WPC, the fusion

Abbreviations: DSC, differential scanning calorimetry; GC, gas chromatography; N, Newton; *phbB*, acetoacetyl-CoA reductase; *phbC*, PHB synthase; *rbcs*, small subunit of ribulose-1,5-biphosphate carboxylase/oxygenase; *sGFP*, S65T-type green fluorescent protein; T_m, melting point.

^a Present address: Association of International Research Initiatives for Environmental Studies (AIRIES), 3-1-13, Shibakoen, Minatoku, Tokyo 105-0011, Japan

This article can be found at <http://www.jspecmb.jp/>

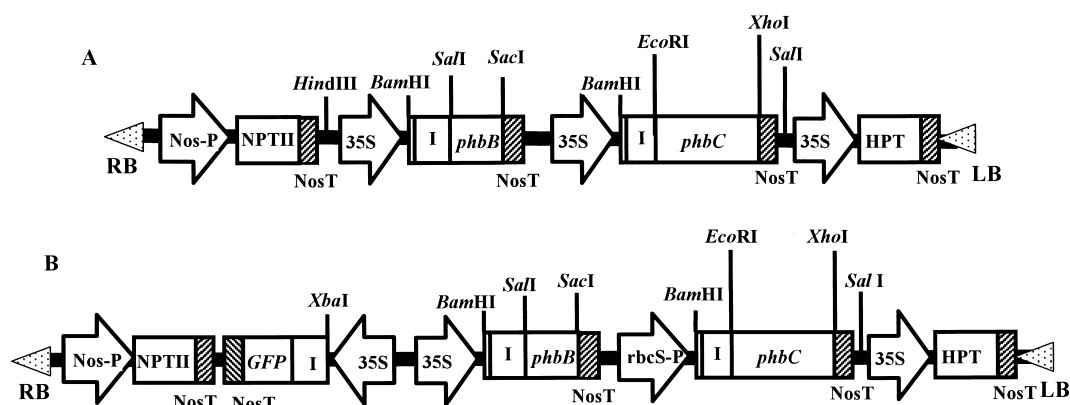

Figure 1. Schematic representations of the vector used for the transformations into rice (A) and Tamarix (B). RB: right border; LB: left border, Nos-P: promoter of the nopaline synthase gene; NosT: polyadenylation sequence of the nopaline synthase gene; NPT II: the neomycin phosphotransferase gene; 35S: CaMV 35S promoter; I: first intron of castor bean catalase; HPT: the hygromycin phosphotransferase gene; *GFP*: S65T-type green fluorescent protein gene; *rbcS-P*: the promoter of the *rbcS-3B* gene from tomato. The restriction sites are indicated. The effect of the castor bean catalase intron on the translation of *sGFP* was confirmed in rice and *Agrobacterium* (see Figure 5B).

of plastic within a fiber cell looks like a promising method for producing WPC materials. Based on these studies, we attempted to change cell properties by accumulating a small amount of PHB for targeting WPC production. Two genes, *phbB* and *phbC*, were employed in the transformation event, whereas *phbA* was not integrated into the plant cells due to its endogenous activity as a competitor for acetyl-CoA (Lössl et al. 2003). The term ‘hybrid fiber’ is used to describe WPC materials made of plant fibers that are filled with plastics, and we will discuss the result of potential property changes in a sample board made of transgenic plant cells containing PHB.

Materials and methods

Plant materials

Rice (*Oryza sativa* L. var. Nipponbare) and Tamarix (*Tamarix* spp., salt cedar) were selected as host plants. Tamarix is a bushy tree with slender branches and small, alternate, scale-like leaves similar to those of pine trees. It is able to survive in a wide variety of habitats and conditions, including submergence, saline environments, and drought (Frasier and Johnsen 1991). Tamarix appears to grow best in saline soils and can tolerate solutions with higher salt levels than that of seawater (Endo et al. 2005). The genus Tamarix is native to a zone that stretches from southern Europe and North Africa through the Middle East and south Asia to China (Frasier and Johnsen 1991).

Although little has been reported about transformation in Tamarix, this plant was targeted for the gene transfer due to its wood quality and the fact that it can be grown even in severely damaged land, such as a desert. Rice is a monocot that has a hemicellulosic component like xylan, which is similar to trees, rather than the xyloglucan-rich hemicellulose found in dicots (Carpita and Gibeaut

1993).

Plasmid construction

The coding regions of *phbB* (Accession number: J09487) and *phbC* (Accession number: J05003) were amplified by the polymerase chain reaction (PCR) from the genomic DNA of *Ralstonia eutropha*, which was prepared by Dr. Asada (National Institute of Bioscience and Human Technology, Tsukuba, Japan). The vector was constructed using PCR products representing a castor bean catalase intron (Ohta et al. 1990), the *rbcS-3B* promoter from tomato for woody-plant expression (Sugita et al. 1987; Matsunaga et al. 2002), and the Nos terminator for *phbC* (Figure 1). All PCR fragments were sub-cloned into pPCR-Script Amp SK(+) (Stratagene) and sequenced. The following primers were used for the PCR amplifications: *phbB*, 5'-GGTCGACCTACTCAGCGCATGTC-3' (forward) and 5'-CCGAGCTCGCAGGTCAGCCCATAT-3' (reverse); *phbC*, 5'-TGGAATTCTGCGACCGGCAAAGGC-3' (forward) and 5'-GGCTCGAGTCATGCCTTGGCTTTGT-3' (reverse); the first intron of castor bean catalase for *phbC*, 5'-GGTCTAGAACATGGATCCCTACGC-3' (forward) and 5'-CCGAATTCCTCGACGGTTCTGTAA-3' (reverse); the first intron of castor bean catalase for *sGFP*, 5'-GGTCTAGAACATGGATCCCTAC-3' (forward) and 5'-CCGATATCGTTCTGTAACATATCATC-3' (reverse); the *rbcS-3B* promoter, 5'-TTAAGCTTGGATGTTAATGATACTTC-3' (forward) and 5'-AAGGATCCGACAATAATTGGTCTCTAG-3' (reverse); the polyadenylation sequence of the nopaline synthase gene for *phbC*, 5'-TTCTCGAGGCGAATTTCCCGGATC-3' (forward) and 5'-CCGTCGACGATCTAGTAACATAG-3' (reverse). The restriction sites are shown in Figure 1A. For the construction of the intron-*sGFP* marker for Tamarix, the first methionine codon of *sGFP* (ATG) was substituted by a lysine codon (AAG) using a QuickChange II site-

directed mutagenesis kit (Stratagene) after inserting the first intron of castor bean catarase. The effects of the intron on the translation of *sGFP* were confirmed by comparing the expression levels of *sGFP* in *Agrobacterium* and transgenic rice. All ligated sites were sequenced after each construction step. The vector, marker genes, and bacterial collections were contributed by the following labs: pIG221 and pIG121Hm from Dr. K. Nakamura (Nagoya University, Japan), the tomato *rbcS* promoter from Dr. M. Sugita (Nagoya University), *sGFP* from Dr. Y. Niwa (University of Shizuoka, Japan), *EHA101* from Dr. E. Hood (Prodigene Inc., USA), and *GV3101* from Dr. C. Konz (Max Planck Institute for Plant Breeding Research, Germany).

Transformation in rice

A binary vector bearing tandemly connected *phbB* and *phbC*, and *hpt* as a selection marker gene (Figure 1) was constructed and introduced into *Agrobacterium tumefaciens* strain *EHA101*. Rice was transformed as described elsewhere (Endo *et al.* 2005). Regenerated plantlets (T_0 generation) were transferred into a confined greenhouse and grown until flowering in soil-containing pots. T_0 plants were self-pollinated to produce T_1 plants or crossed with Koshihikari, a rice variety, to produce F_1 plants. Plants that showed *phbB* and *phbC* expression were propagated by dividing tillers.

Transformation in Tamarix

Due to the lack of reports about an established regeneration and transformation system in *Tamarix*, we attempted to establish a gene transfer system by trial and error. We were eventually able to confirm the expression of the transformed genes in the tissues of multiple shoots in our transient system. The multiple shoot formation was realized in MS medium: 30 g l⁻¹ sucrose (Wako, Osaka, Japan), 0.1 mg l⁻¹ *N*-(2-Chloro-4-pyridyl)-*N'*-phenyl urea (Sigma), and 0.01–0.3 mg l⁻¹ NAA (Sigma) at pH 5.8. The lower BA concentration and NAA in partially hormone-free conditions resulted in the vigorous production of multiple shoots in a sub-culture.

After a 30-day culture, multiple shoots were subjected to *Agrobacterium*-mediated co-transformation (strains *EHA101* and *GV3101*). Multiple shoots were soaked in a bacterial suspension (OD=0.8), which consisted of half MS basic medium (pH 5.2) supplemented with 5 mM MES, 5% sucrose, and 10 mg l⁻¹ acetosiringon. Vacuum infiltration (75 mmHG) was applied for 5 to 15 min after sonication for 2 min. After placing the infiltrated multiple shoots on a solid medium to induce multiple shoot formation containing 10 mg l⁻¹ acetosiringon, shoots were cured at 22°C for 3 days, followed by washing with 250 mg l⁻¹ clavulanic acid potassium salt and 250 mg l⁻¹ amoxicillin tri-hydrate for 1 min. Selection for the introduction of the genes was done by

way of hygromycin resistance and *sGFP* fluorescence. Fluorescent shoots were identified under a fluorescence microscope (Leica, Germany). Selected segments were stored at 80°C for further analysis. Fluorescence of *sGFP* in plant extracts was determined with a Fluorometer (Versa Fluor, BioRad). Monoclonal antibodies against GFP (Medical and Biological Laboratories Co., Ltd., Nagoya, Japan) were used for the detection of GFP protein.

Genomic PCR and RT-PCR analysis

Total DNA isolated from the leaves or young stems of rice and multiple shoots of *Tamarix* using a DNeasy Plant Mini Kit (Qiagen, Hilden, Germany) was used for PCR analysis (Gene Amp PCR system 9700, Applied Biosystems, CA, USA). Primers were designed to amplify the DNA regions between NosT and *phbB*, or between NosT and *phbC*. The primers used to amplify the *phbB* region were 5'-ATGGCACTGGCGCAGGAA-3' and 5'-CTAGTAACATAGATGACACCGC-3'. The primers used to amplify the *phbC* region were 5'-CAGCCACTGGACTAACGAT-3' and 5'-CTAGTAA-CATAGATGACACCGC-3'. The PCR conditions using KOD-dash polymerase (Toyobo, Osaka, Japan) were as follows: 2 min at 98°C, followed by 30 cycles of 30 sec at 98°C, 2 sec at 50°C, and 30 sec at 74°C, and a final extension step of 5 min at 74°C.

Total RNA was extracted from 100 mg of leaves of rice or multiple shoots of *Tamarix* using an RNeasy Plant Mini Kit (Qiagen, Hilden, Germany). RT-PCR was performed using an Omniscript Reverse Transcriptase Kit (Qiagen), followed by the PCR under the same conditions as those used for genomic PCR analysis. The primers used for RT-PCR analysis of *phbB* were 5'-ATCAACAACGCCGGTATCAC-3' and 5'-GACGAGATGTTGACGATGCG-3'. The primers used for RT-PCR analysis of *phbC* were 5'-ATGATGGAA-GACCTGACACG-3' and 5'-TAGATATAGGTCGG-CACGTC-3'.

Enzymatic analysis of *phbB*

Protein samples were obtained by grinding fresh leaves (100 mg) in liquid nitrogen, followed by homogenization in extraction buffer (10 mM HEPES, 5 mM DTT, and 0.3 M sorbitol at pH 7.5) with complete mini protein inhibitor cocktail (Roche, Germany), and clarification by centrifugation for 20 min at 18,000×*g* at 4°C. The activity of acetoacetyl-CoA reductase (*phbB*) was assayed according to the procedure described by Nakashita *et al.* (1999). An aliquot of clarified leaf extract containing 200 μg of the protein sample was added to 500 μl of reaction mix (12 μM MgSO₄, 0.5 mM DTT, and 0.1 mM NADPH in potassium phosphate buffer at pH 7). The reaction was started by the addition of the acetoacetyl-CoA substrate to a final concentration

of 0.1 mM. The absorbance at 340 nm was measured with a spectrophotometer (Beckman DU-640) to determine the amount of NADPH after the reaction.

Western blot analysis for *phbC*

Protein samples were prepared in the same manner as they were for the *phbB* assay. Each sample (20 μ g) was mixed with Laemmli buffer (BioRad), heated for 10 min at 100°C, and separated on a 10–20% SDS-polyacrylamide gel (Ready Gel J, BioRad). After the electrophoresis (100 V for 75 min), proteins were electroblotted (Trans Blot SD, BioRad) onto a PVDF membrane (Hybond P, Amersham). The membrane was then used for immunodetection using an ECL Plus kit (Amersham) and antibodies specific for the 20 C-terminal amino acids of *phbC* (N-GNARYRAIEPAPGRYVKAKA-C) (a gift from Dr. Doi, RIKEN, Japan).

Analysis of PHB by gas chromatography (GC)

The PHB content in the plants was analyzed according to the methods described in Nawrath et al. (1994) and Nakashita et al. (1999) with slight modifications. Transgenic plants were cut and washed four times with 50% ethanol (50 ml at 55°C for 1 h), washed once with 100% methanol (50 ml at 55°C for 1 h), and ground into a powder in liquid nitrogen with a mortar and pestle.

Ten grams of the powder was added to 3 ml of chloroform, incubated for 12 h at 60°C, and filtered. The filtrate was mixed with 17 ml of ethanol and 3 ml of HCl, and incubated for 4 to 6 h at 100°C (ethanolysis), after which 5 ml of 0.9 M NaCl was added and mixed well. After the phases were allowed to separate, the chloroform phase was recovered and dried in vacuo. The PHB content was determined by GC (Autosystem XL, Perkin Elmer). Bacterial PHB (Aldrich) was used as a control. A PHB sample from *R. eutropha* also was prepared, subjected to ethanolysis, and used for GC analysis. The injector and detector were heated to 280°C. The initial column temperature was set at 100°C for 10 min. Subsequently, the temperature was increased by 8°C min⁻¹ until a final temperature of 280°C was reached. The retention time was 5 min. The flow rates of air, hydrogen gas, and the carrier gas (nitrogen) were 500 ml min⁻¹, 50 ml min⁻¹, and 60 ml min⁻¹, respectively. One microliter of the sample was injected. Methyl octanoate was used as a retention time marker.

Preparation of samples for the measurement of hybrid fiber properties

Five types of boards were prepared: (i) a cellulose-PHB board, (ii) a plant powder-PHB board, (iii) a PHB-absorbed board, (iv) a transgenic rice board, and (v) a transgenic Tamarix board. Bacterial PHB (Aldrich) was dissolved in chloroform by heating at 100°C for 15 min, and mixed with cellulose powder (Sigma). After being

dried at room temperature, the mixture was pelletized (diameters: 10 and 30 mm, thickness: 2–5 mm) using hydraulic press pelletizers (Graseby Specac Ltd., UK, and Shimadzu Co., Japan, respectively) at 6–9 tons to make the cellulose-PHB board. The leaves of non-transformed rice were dried at 60°C for 24 h, and powdered using a Wonder Blender (WB-1, Osaka Chemical, Japan). This powder was used to make the plant powder-PHB board in the same way as was described for the cellulose-PHB board. Commercial plywood was cut into the same pellet form as that of the cellulose-PHB board, soaked in a bacterial PHB solution in chloroform, and decompressed to make the PHB-absorbed board. The leaves of transgenic rice that contained PHB were dried at 60°C for 24 h, and powdered using the blender, after which the powder was pelletized to make the transgenic rice board. Multiple shoots of Tamarix that were selected for *sGFP* expression were dried, powdered, and pelletized to make the transgenic Tamarix board.

Measurement of thermal properties by differential scanning calorimetry (DSC)

After making a composite board sample (10 mm ϕ cylinder), each sample was set on the DSC instrument (Exstra6000 TG/DTA 6300, Seiko Instrument Inc.). The measurement was done in a range from 20–200°C with a rate of temperature increase of 10°C min⁻¹ in nitrogen gas. The melting point (T_m) was measured as a peak in the DSC curve that was present at a suitable temperature, which was different than the peak of pure PHB and the DSC curve of pure cellulose samples.

Measurement of the thermal extension rate (α)

As a measurement of thermal stability, the mean linear extension (length) was determined in a range from room temperature to 80°C by a Rigaku thermo-mechanical analyzer (8141BH). An R-type thermocouple was used with an increasing rate of temperature of 10°C min⁻¹ in air. Silica was used as a standard.

Force compression analysis

The force compression relationships of the sample boards were determined with a Tensilon Model RTM-50 Universal Tensile Testing Instrument (Toyo Baldwin, Japan). The test sample was fixed between the lower and upper movable clamps at a distance of 10 mm, and then compressed at a speed of 2 mm min⁻¹. The compression was discontinued when the sample was crushed. The sample was then removed from the clamps, dried for 48 h at 60°C, and weighed for the calculation of the pressure per unit (Newtons).

Measurement of moisture absorption

Sample boards were oven dried (105°C for 2 days) and

immediately placed in desiccators for cooling. After the weight of the boards was measured at room temperature, they were placed in an airtight moisture box (30 cm×40 cm×20 cm), which contained a water basin with a net holder. The sample was placed on the net, and the box was tightly closed. The weight of the sample was measured periodically and a net increase in the weight was considered to reflect moisture absorption. Each sample was tested three times.

Results and discussion

phbB- and *phbC*-expressing transgenic rice

Figure 2 shows the result of a PCR using the genomic DNA from the T_0 rice plants. The plasmid that we transformed into the rice carried cassettes of *phbB* and *phbC* with the selection marker gene *hpt* (Figure 1). The presence of only a single gene, however, was often observed (lane 6 in Figure 2). Of the 112 T_0 plants examined, 53 (47%) appeared to possess both *phbB* and *phbC*, whereas 19 (17%), 33 (29%), and 7 (6%) carried only *phbB*, only *phbC*, and no transgenes, respectively. We obtained 142 T_1 plants from 24 T_0 lines and F_1 lines derived from crosses with Koshihikari. Of 2,366 total T_2 and F_2 plants, we obtained 615 plants that carried both *phbB* and *phbC*. These results suggest that although the two genes could be introduced into the rice genome, one or both of the genes were often lost not only during the transformation procedure, but also later on during the propagation of the carrier plants.

The expression of the introduced genes in the transgenic rice was confirmed by RT-PCR analysis (Figure 3). Of the 615 plants from the T_2 and F_2 populations that were PCR-positive for both *phbB* and *phbC*, 10% expressed *phbB*, whereas 30% expressed *phbC*. Less than 1% of the plants expressed both *phbB* and *phbC*. These results suggest that in these plants, the expression of the transgenes was silenced. During the transformation of plants, transgene silencing is a common phenomenon (Meyer and Saedler 1996). Many factors are responsible for this instable transgene expression, including the tendency for exogenous DNA to undergo rearrangement, position effects, the number of transgenes introduced, sequence homology-related factors, and DNA methylation (Mayer and Saedler 1996; Elmayan and Vaucheret 1996; Chareonpornwattana et al. 1999; Fu et al. 1999; Kohli et al. 1999). In rice transgene cassettes driven by the CaMV35S promoter, a recombination hot spot in the sequence was determined to be responsible for microhomology-mediated recombination (Kohli et al. 1999). An illegitimate recombination may occur between two plasmids or between a plasmid and the genome before or during the integration event into the genomic DNA. In the present study, we constructed *phbB* and *phbC* cassettes, each

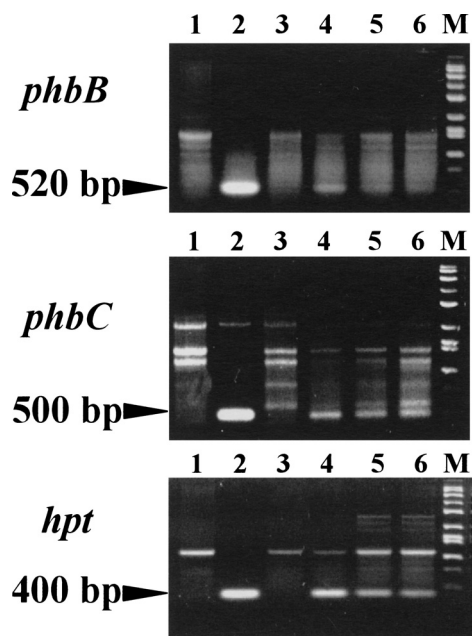

Figure 2. Genomic PCR analysis for the selection of *phbB* and *phbC* genes in rice. The arrowheads mark the expected 520-bp, 500-bp, and 400-bp PCR products that indicate the presence of *phbB*, *phbC*, and *hpt*, respectively, in the samples. Lane 1: rice variety Koshihikari; Lane 2: vector; Lane 3: rice variety Nipponbare; Lanes 4–5: transgenic T_0 plants carrying *phbB* and *phbC*; Lane 6: a transgenic T_0 plant carrying *phbC*; M: size marker

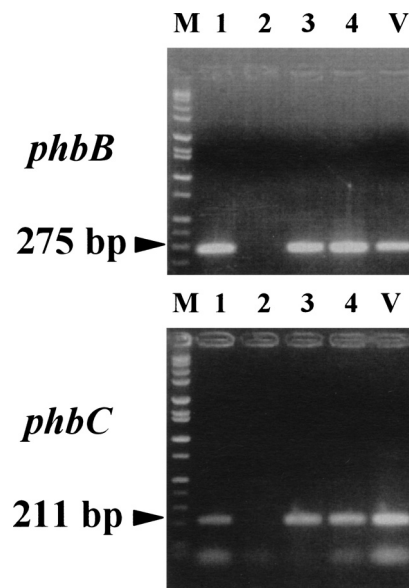

Figure 3. RT-PCR analysis detecting the expression of *phbB* and *phbC*. The arrowheads mark the expected 275-bp and 211-bp PCR products that indicate the expression of *phbB* and *phbC*, respectively, in the samples. M: size marker; Lanes 1 to 4: transformed rice samples; V: vector (pBI121Hm).

driven by a CaMV35S promoter (Figure 1). The lack of either *phbB* or *phbC* was often observed not only after the transformation event (T_0) but also in the subsequent sexual generations (T_1 , F_1 , and successive generations).

It appears that the illegitimate recombination events were often accompanied by transgene escape or instable gene transmission.

The gene silencing may occur at both the transcriptional and post-transcriptional levels (Matzke and Matzke 1995; Elmayan and Vaucheret 1996). In this study, RT-PCR analysis suggested that the gene silencing occurred at the transcriptional level; less than 1% of the plants expressed both *phbB* and *phbC*. Many factors have been reported to contribute to transcriptional silencing in rice, including methylation-related silencing (Fu et al. 1999), hemi- or homozygous conditions with multiple copy numbers (Chareonpornwattana et al. 1999), and CaMV35S promoter orientation instability (Kohli et al. 1999). Most of these factors involve the CaMV35S promoter, which was also used in the present study. Because of the possible instabilities associated with the CaMV35S promoter, a different promoter was used for the Tamarix transformation (Figure 1B). Although the same cassettes were also examined in rice, no clear-cut results were obtained due to lower seed fertility (data not shown). Further improvements on the plasmid structure should lead to more efficient transgene activation.

Gene function analysis

The 20 plants found to carry both *phbB* and *phbC* by genomic PCRs were tested for enzyme activities. Three plants were found to be positive for the enzyme activities, ranging from 5 to 46 mU mg⁻¹ of the proteins. One of the three plants (IBIC251) was confirmed to express both *phbB* and *phbC* by RT-PCR. The other two plants expressed only *phbB*, whereas the remaining 17 plants did not express either of the genes. These results further confirmed the transcriptional gene silencing of *phbB* and that the transformed *phbB* was functional.

The *phbC* protein (64.3 kDa) was detected by Western blotting analysis (Figure 4). Of the seven plants that carried both *phbB* and *phbC* and expressed *phbC*, analysis of five of the plants resulted in immunopositive bands. This band was also present in 20 µg of protein extracted from *R. eutropha*, whereas it was not detected in non-transformed Nipponbare. Although several unknown bands were detected of the all lanes, the 64.3-kDa band was specific to the transformants. The identities of the extra bands are unknown; they, however, are also observed during analysis of transgenic tobacco plants (Nakashima et al. 1999).

One of the five plants (IBIC251) was confirmed to express both *phbB* and *phbC*. This result showed that the integrated *phbC* was functional, thereby suggesting that *phbC* expression is inhibited by post-transcriptional gene silencing, as has been previously reported in tobacco (Elmayan and Vaucheret 1996). Although several hypotheses have been formulated to explain the post-transcriptional gene silencing (Matzke and Matzke

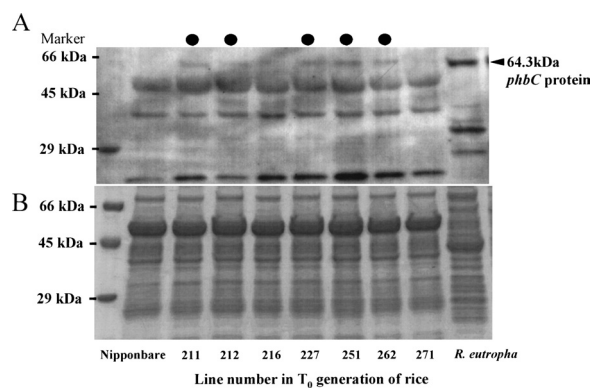

Figure 4. Western blot analysis of shoot protein extracts from T₀ rice. (A) Western blot; (B) SDS-PAGE. The arrowhead indicates the 64.3-kDa band that corresponds to the *phbC* protein. ●: the presence of *phbC* protein.

1995), an explanation that allows the prediction of this phenomenon has yet to be established. Nevertheless, this unpredictable silencing seems to have occurred in our system, and may inhibit the efficiency of PHB accumulation.

Selection of Tamarix shoots carrying *phbB* and *phbC*

Multiple shoots were obtained from a culture of Tamarix by trial and error. The selected assay system showed an effective transformation rate after the addition of the vacuum infiltration and sonication steps (Figure 5A). The combination of these two treatments increased *sGFP*-positive shoots to 30% of the total number of shoots examined. The *sGFP*-positive shoots were collected under a microscope and propagated on a medium. Because of potential transgene inactivation, as was discussed for rice, the gene cassettes were modified for the Tamarix transformation (Figure 1B). The stability of these cassettes, however, was not tested due to a lack of gene transmission into next generation. Fluorescence due to residual bacterial mass was determined in relation to the presence of the introduced castor bean catalase intron (Ohta et al. 1990) (Figure 5B). The presence of the intron reduced the magnitude of the fluorescence signal from the *sGFP*, and the fluorescence was observed only in the Tamarix tissue, but not in the bacterial cells where the intron was not efficiently removed. These results suggested that the *sGFP* fluorescence was not due to residual bacteria, but instead was due to the introduced gene in the Tamarix tissue. Based on these results, the presence of *phbB* and *phbC* in the tissues was confirmed batch by batch (Figure 5C).

PHB accumulation in rice and Tamarix

In the present study, ethanolysis was employed because of clear peak presence unlike that of methanolysis, which has generally been used for bacterial PHB detection

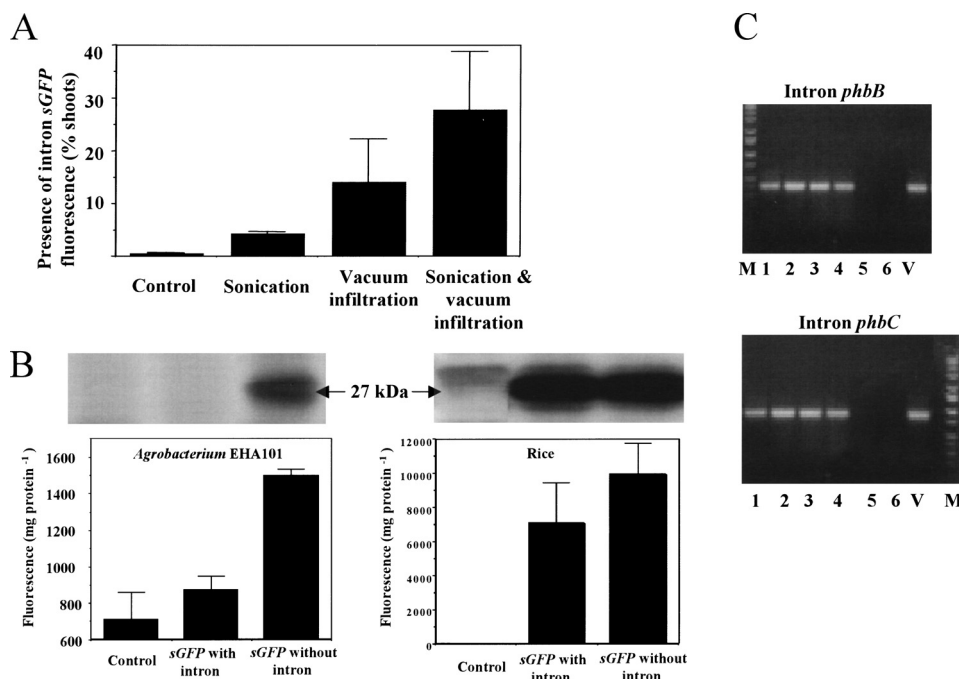

Figure 5. Transformation of multiple shoots of Tamarix by *Agrobacterium* based on the intron-*sGFP* marker. (A) The effect of sonication and vacuum infiltration on the transformation of multiple shoots of Tamarix with strain EHA101. (B) The effect of the castor bean intron on the GFP protein translation was confirmed in rice and *Agrobacterium*. (C) Genomic PCR analysis for the presence of intron-*phbB* and intron-*phbC*. Lanes 1–4: transformed Tamarix; Lanes 5 and 6: non-transformed Tamarix; M: size marker; V: vector. Each lane represents a batch of intron-*sGFP*-positive buds ($n=50$).

(data not shown). As shown in Figure 6, a peak corresponding to PHB was detected in the transformed rice (Figure 6C, 6D). This peak was not present in non-transformed rice (Figure 6B). The content of PHB in the transformed rice, in which the expressions of *phbB* and *phbC* were confirmed by RT-PCR analysis, varied from 0.2 to 5 mg gDW⁻¹ (average=3.4 mg gDW⁻¹; $n=5$; SE=2.5). The PHB accumulation in *R. eutropha* was almost 20% DW. In addition, only a few of the plants that expressed *phbB* and *phbC* showed a detectable amount of PHB. A similar level of PHB (3.2 mg gDW⁻¹) was obtained in transformed Tamarix.

The values obtained in this study were in line with other studies that looked at different plants, though the transformed genes and targeting techniques we used were not the same: 20–100 $\mu\text{g gFW}^{-1}$ in *Arabidopsis* (Poirier et al. 1992), 14% DW in *Arabidopsis* (Nawrath et al. 1994), less than 10 $\mu\text{g gFW}^{-1}$ in tobacco (Nakashita et al. 1999), 0–7.7% FW in Brassica (Houmiel et al. 1999), 4% FW in *Arabidopsis* (Bohmert et al. 2000), 2 to 8 ppm DW in tobacco (Nakashita et al. 2001), maximal values of 3.2 mg gDW⁻¹ in tobacco, 0.09 mg gDW⁻¹ in potato, and 132 mg gDW⁻¹ in *Arabidopsis* (Bohmert et al. 2002), 1.7% DW in tobacco (Lössl et al. 2003), 55 mg gDW⁻¹ in sugar beet (Menzel et al. 2003), and 4.62 $\mu\text{g gFW}^{-1}$ in flax (Wróbel et al. 2004). It has been reported that growth retardation often accompanies the transformation, as is the case in tobacco (Lössl et al. 2003). No typical morphological changes,

however, were commonly observed, except that the height of the plants was generally lower and the number of grains was reduced. This may be partially attributable to the conditions in the closed greenhouse. One of the rice lines, IBIC251, in which *phbB* and *phbC* expressions, *phbB* enzyme activity, *phbC* protein expression, and the accumulation of PHB were confirmed, was weak and finally died. The reduced accumulation of PHB and growth retardation may be attributable to β -ketothiolase or to the competition for substrates such as acetyl-CoA (review of Madison and Huisman 1999). A similar phenomenon may occur in the transgenic rice.

Thermal property changes measured by DSC

The T_m of a pure bacterial PHB sample was 176.83°C (Figure 7), which is close to the melting point of PHB (review of Madison and Huisman 1999). T_m values for the 10% and 20% PHB blends of the cellulose-PHB boards were 175.00°C and 174.83°C, respectively (Figure 7B, 7C). This result indicates that the addition of bacterial PHB to plant tissues lowers the T_m values of the sample board.

In the samples prepared from transformed and non-transformed rice, gene expressions were confirmed by RT-PCR. For the sample made of transformed rice, DSC revealed a weak but unique peak at 155.00°C, presumably due to the lower level of PHB accumulation. This peak was not observed for the sample board made

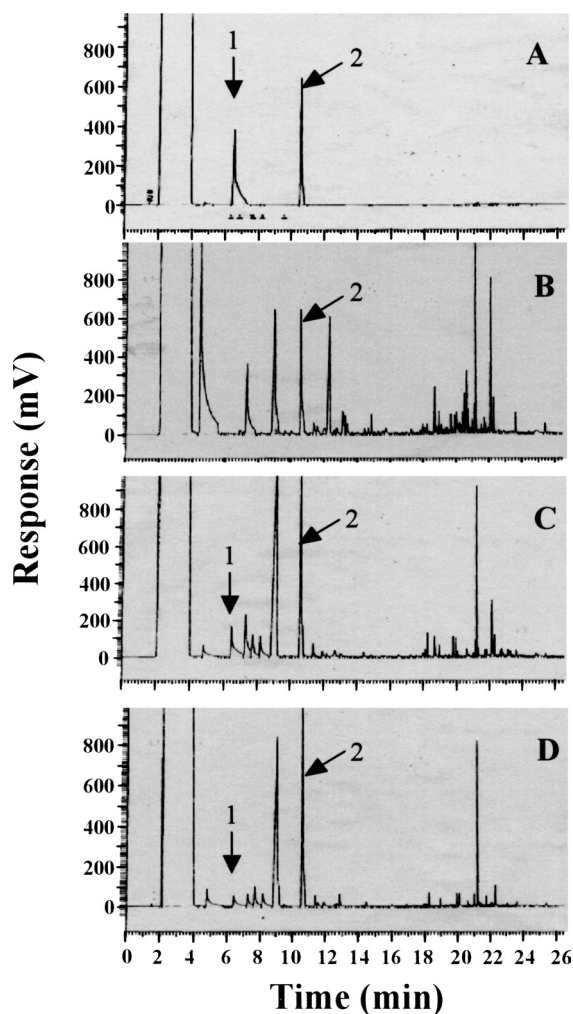

Figure 6. Gas chromatography of transformed rice. A: control (2% PHB), B: Nipponbare (non-transformed), C: IBIC24 (transformed), D: IBIC240 (transformed). Peaks 1 and 2 correspond to PHB and the internal standard, respectively.

of non-transgenic rice (Figure 7E, 7F). This peak was different from the T_m value of chlorophyll (117–120°C) or carotenoids (180°C). These results suggested that the thermal properties of PHB changed when it was combined in the plant cells.

Mechanical properties: resistance to compression

Deformation curves were analyzed to determine the breaking stress force, which is a measure of the compression resistance of the sample board. The result showed that the breaking stress of the sample shifted from 488 Newtons (N) to and 588 N when PHB content increased in the plant powder-PHB board from 0 to 4% (Table 1). This result shows that the PHB in the sample board increased the resistance to compression of the board by 20%, and allowed the board to retain its shape at higher pressures.

When the transgenic rice board was examined, a

similar result was obtained; the breaking stress was 508 N for non-transformed rice board and 576 N for transformed rice board (a 13% increase) (Table 1). The introduced genes also increased the resistance to compression of the Tamarix board by 16%. In this test, a 4% PHB blend was used together with a 0.1% blend to obtain PHB values close to those in the transformed plant. These results showed that the incorporation of PHB into the plant cells influenced the deformation resistance of the resulting samples to the same degree as the sample of the plant powder-PHB blend, and that the introduction of the genes for PHB synthesis changed the physical properties of the sample board, though the level of PHB in the transformed rice was lower than that in the plant powder-PHB blend.

Thermal extension rate (α)

The thermal extension rate is a measure of the change in length of a sample over a range of temperatures (Table 1). Based on the analysis of the curve obtained in the range of room temperature to 50°C, it was shown that the 4% PHB blend reduced the extension rate by almost 80% compared to the 0% blend (21.2 in contrast to 101). Similar results were obtained for the sample made of transformed rice (74% reduction) and transformed Tamarix (66% reduction), when compared to the non-transformed samples (Table 1).

Moisture absorption

Board samples made of commercial plywood, in which PHB was absorbed, together with cellulose-PHB board and transgenic plant boards were analyzed for moisture absorption. It was shown that the cumulative absorption of moisture by plywood without PHB was higher than the intact commercial plywood: 0.3 mg gDW⁻¹ and 0.2 mg gDW⁻¹, respectively (Table 1). In contrast, the absorption value of composite board without PHB was 0.75 mg gDW⁻¹, whereas that of composite board with 4% PHB was 0.70 mg gDW⁻¹ (Table 1). In comparison with non-transformed rice, the moisture absorption rate of the transformed rice material was significantly decreased: almost 92% of the non-transformed rice. This decrease was even greater in the transformed Tamarix sample; the value of the transformed Tamarix sample was 73% of the value of the non-transformed Tamarix sample: These results suggest that moisture absorption depend mainly on the basic materials, and that the incorporation of PHB could effectively reduce moisture absorption not only in the blended samples but also in the transgenic plants.

The potential for biological WPC production by genetic engineering

Melting plastics inside plant tissues generally gives rise to hydrophobic wood materials (review of Madison and

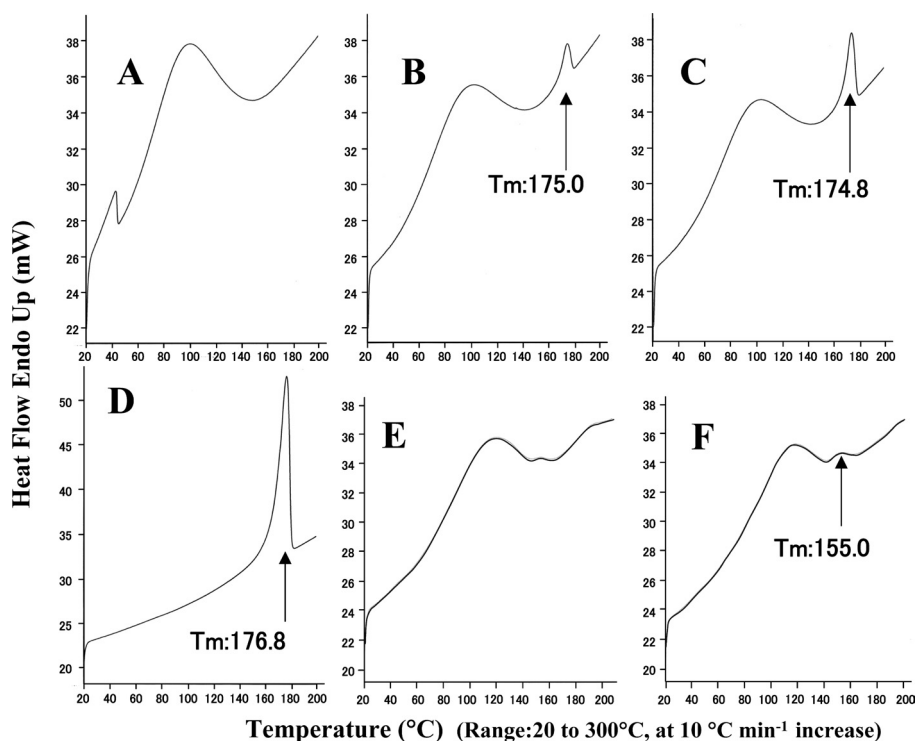

Figure 7. DSC measurements for cellulose (A), a 10% PHB blend (B), a 20% PHB blend (C), 100% PHB (D), non-transformed rice (E), and transformed rice (F).

Table 1. Transition of thermo-physical properties in transgenic rice and Tamarix with genes for PHB synthesis.

	Breaking Stress Force (N)	Thermal extension rate (α) Room temp $\sim 50^{\circ}\text{C}$ ($\times 10^{-6}\text{C}^{-1}$)	Moisture absorption Water content after 72 hrs (mg g^{-1} dry weight)
PHB blend (rice powder)			
PHB 0%	488 \pm 10	101.0 \pm 11.3	0.75 \pm 0.06
PHB 0.1%	553 \pm 13	—	—
PHB 4%	588 \pm 18	21.2 \pm 4.4	0.70 \pm 0.04
PHB absorbed board			
without PHB	—	—	0.30 \pm 0.03
with PHB	—	—	0.20 \pm 0.02
Rice			
Non-transformant	508 \pm 8	100.0 \pm 12.7	0.77 \pm 0.02
Transformant	576 \pm 2	25.5 \pm 5.7	0.75 \pm 0.02
Tamarix			
Non-transformant	516 \pm 29	64.3 \pm 7.5	1.20 \pm 0.06
Transformant	600 \pm 29	22.0 \pm 4.2	0.87 \pm 0.04

Data in the figure are shown as mean \pm standard error (SE) with more than two replications.

Huisman 1999). WPC materials are normally produced by introducing synthetic monomers into the wood, which are then polymerized in the wood by radiation, heat, or pressure. We assumed that the PHB content in the transgenic sample was less than 3 mg gDW^{-1} . Presumably, the level of PHB in the bulked powder was lower than this value due to the instability of the introduced genes. The plastic content of ordinary WPC material is at least 10-fold higher or more. Therefore, the DSC measurements (Figure 7) for the 10% and 20% PHB blends were compared to the cellulose-PHB sample that did not show any clear peak corresponding to the

melting point, whilst in the successive tests, we considered PHB levels that were closer to those in the transformed plants.

As has shown here, the accumulation of PHB in plant cells results in an improvement in the thermo-physical properties of the material. In response to potential environmental hazards, technologies that are friendly to the environment are desired. WPC production with biodegradable plastics can provide a renewable material that does not result in an increase in CO_2 levels. For example, Godbole *et al.* (2003) attempted to produce films by blending starch and PHB. Further advances

were presented in two reports on transgenic cotton fibers (John and Keller 1996; Chowdhury and John 1998). These reports accessed the property changes in cotton fiber carrying PHB synthesis genes. Changes in the mechanical properties of flax fiber were also reported after the introduction of PHB synthesis genes (Wróbel et al. 2004). Changes in a single fiber cell, however, do not necessarily reflect the characteristics of the resulting WPC material, because of possible effects from the interactions between the cells. In this study, we showed the first evidence of the characteristic transition of WPC materials made from transformed plants. Although the PHB content was very low, the changes in the properties of the sample boards appear to be larger than in the blends of the same levels of PHB. We transformed the genes for the synthesis of poly-3-hydroxybutyrate into rice and Tamarix, and the hydrophobic characteristics of the PHB enhanced the strength of the resulting composite boards. However, a fragileness was accompanied on the other hand. These complex quality requirements for the product may be improved by using different PHA synthesis genes, such as 4-hydroxybutyrate (4HB) or copolymers of 3HB and 4HB (Saito and Doi 1994). Future studies will access these possibilities for the production of biological WPC.

Acknowledgments

The authors would like to thank to Dr. Ono (Tokyo University) for his technical help and advice about DSC, and Mr. Ohmura (Taisei Corp.) for his technical assistance about the Tamarix and rice cultures as well as the microscopic work. This study was supported as a project of the New Energy and Industrial Technology Development Organization (NEDO) under the foundation of the Ministry of Economy, Trade, and Industry of Japan.

References

- Bohmert K, Balbo I, Kopka J, Mittendorf V, Nawrath C, Poirier Y, Tischendorf G, Trethewey RN, Willmitzer L (2000) Transgenic *Arabidopsis* plants can accumulate polyhydroxybutyrate to up to 4% of their fresh weight. *Planta* 211: 841–845
- Bohmert K, Balbo I, Steinbüchel A, Tischendorf G, Willmitzer L (2002) Constitutive expression of the β -ketothiolase gene in transgenic plants. A major obstacle for obtaining polyhydroxybutyrate-producing plants. *Plant Physiol* 128: 1282–1290
- Carpita NC and Gibeaut DM (1993) Structural models of primary cell walls in flowering plants: consistency of molecular structure with the physical properties of the walls during growth. *Plant J* 3: 1–30
- Chareonpornwattana S, Thara KV, Wang L, Datta SK, Panbangred W, Muthukrishnan S (1999) Inheritance, expression, and silencing of a chitinase transgene in rice. *Theor Appl Genet* 98: 371–378
- Chowdhury B, John ME (1998) Thermal evaluation of transgenic cotton containing polyhydroxybutyrate. *Thermochimica Acta* 313: 43–53
- Elmayan T, Vaucheret H (1996) Expression of single copies of a strongly expressed 35S transgene can be silenced post-transcriptionally. *Plant J* 9: 787–797
- Endo N, Yoshida K, Akiyoshi M, Yoshida Y, Hayashi N (2005) Putative UDP-galactose epimerase and metallothioneine of *Paspalum vaginatum* enhanced the salt tolerance of rice, *Oryza sativa* L. from transplanting to harvest stages. *Breeding Science* 55: 163–173
- Frasier GW, Johnsen TN Jr (1991) Saltcedar (Tamarisk): Classification, distribution, ecology, and control. In: James LF, Evans JO, Ralphs MH, Child RD (ed) *Noxious Range Weeds*. Westview Press, Boulder CO, pp 377–386
- Fu X, Kohli A, Twyman RM, Christou P (1999) Differential concurrent transgene silencing associated with distinct types of nonspreading cytosine methylation. *RGN16*: 131–135
- Godbole S, Gote S, Latkar M, Chakrabarti T (2003) Preparation and characterization of biodegradable poly-3-hydroxybutyrate-starch blend films. *Bioresour Technol* 86: 33–37
- Houmiel KL, Slater S, Broyles D, Casagrande L, Colburn S, Gonzalez K, Mitsky TA, Reiser SE, Shah D, Taylor NB, Tran M, Valentin HE, Gruys KJ (1999) Poly (β -hydroxybutyrate) production in oilseed leukoplasts of *Brassica napus*. *Planta* 209: 547–550
- John ME, Keller G (1996) Metabolic pathway engineering in cotton: Biosynthesis of polyhydroxybutyrate in fiber cells. *Proc Natl Acad Sci USA* 93: 12768–12773
- Karpov VL, Malinsky YM, Serenkov VI, Klimanova RS (1960) Radiation makes better wood and copolymers. *Nucleonics* 18: 88–90
- Kohli A, Griffiths S, Palacios N, Twyman RM, Vain P, Laurie DA, Christou P (1999) Molecular characterization of transforming plasmid rearrangements in transgenic rice reveals a recombination hotspot in the CaMV 35S promoter and confirms the predominance of microhomology mediated recombination. *Plant J* 17: 691–601
- Lössl A, Eibl C, Harloff HJ, Jung C, Koop HU (2003) Polyester synthesis in transplastomic tobacco (*Nicotiana tabacum* L.): significant contents of polyhydroxybutyrate are associated with growth reduction. *Plant Cell Rep* 21: 891–899
- Madison LL, Huisman GW (1999) Metabolic engineering of poly (3-hydroxyalkanoates): from DNA to plastic. *Microbiol Mol Biol Rev* 63: 21–53
- Matsunaga E, Sugita K, Ebinuma H (2002) Asexual production of selectable marker-free transgenic woody plants, vegetatively propagated species. *Molecular Breeding* 10: 95–106
- Matzke M4 and Matzke AJM (1995) How and why do plants inactivate homologous (trans)genes? *Plant physiol* 107: 679–685
- Meyer P, Saedler H (1996) Homology-dependent gene silencing in plants. *Annu Rev Plant Physiol Plant Mol Biol* 47: 23–48
- Menzel G, Harloff HJ, Jung C (2003) Expression of bacterial poly (3-hydroxybutyrate) synthesis genes in hairy roots of sugar beet (*Beta vulgaris* L.) *Appl Microbiol Biotechnol* 60: 571–576
- Nakashita H, Arai Y, Yoshioka K, Fukui T, Doi Y, Usami R, Horikoshi K, Yamaguchi I (1999) Production of biodegradable polyester by a transgenic tobacco. *Biosci Biotechnol Biochem* 63: 870–874
- Nakashita H, Arai Y, Shikanai T, Doi Y (2001) Introduction of bacterial metabolism into higher plants by polycistronic transgene expression. *Biosci Biotechnol Biochem* 65: 1688–1691
- Nawrath C, Poirier Y, Somerville C (1994) Targeting of the

- polyhydroxybutyrate biosynthetic pathway to the plastids of *Arabidopsis thaliana* results in high levels of polymer accumulation. *Proc Natl Acad Sci USA* 91: 12760–12764
- Ohta S, Mita S, Hattori T, Nakamura K (1990) Construction and expression in tobacco of a β -glucuronidase (*GUS*) reporter gene containing an intron within the coding sequence. *Plant Cell Physiol* 31: 805–813
- Poirier Y, Dennis DE, Klomparens K, Somerville C (1992) Polyhydroxybutyrate, a biodegradable thermoplastic, produced in transgenic plants. *Science* 256: 520–523
- Saito Y, Doi Y (1994) Microbial synthesis and properties of poly (3-hydroxybutyrate-co-4-hydroxybutyrate) in *Comamonas acidovorans*. *Int J Biol Macromol* 16: 99–104
- Sugita M, Manzara T, Pichersky E, Cashmore A, Gruissem W (1987) Genomic organization, sequence analysis and expression of all five genes encoding the small subunit of ribulose-1, 5-bisphosphate carboxylase/oxygenase from tomato. *Mol Gen Genet* 209: 247–256
- Wróbel M, Zebrowski J, Szopa J (2004) Polyhydroxybutyrate synthesis in transgenic flax. *J Biotechnol* 107: 41–54